

Introduction to the Portia



Flying saucer-shaped led ceiling light, super slim and minimalistic design; it is a faultless combination and deduction of smooth lines, making itself impregnated with ceiling perfectly. Elegant design with soft and even light output realizes a perfect blend of craft and art. High quality PC lamp body promises a higher production efficiency and more stable product quality without any subsequent process. Superior PC diffuser with excellent performance, fire rated UL94-V0, aging resistance and yellowing resistance make this ceiling light with longer lifespan. Slim and light lamp body also in PC, it is a good way to minimize the cost of transportation for customer. Replaceable built-in power supply design with easy maintenance. The driver also adopts fire resistant PC material with higher insulating strength, which promises absolute security. Easy installation, it is twist mounting after fixing the holder on the ceiling, avoid extra nail screw work, safe and convenient.

- Up to 70% energy saving compared to standard CFL
- Long lifetime of 50,000 hours
- Dimmable when using triac dimmer
- 120° wide beam angle
- CCT: 3000K 4000K 5000K 5700K
- No UV/IR light
- Environment friendly, without Mercury or any other hazardous substances

Application notes

- IP40 for indoor use
- Professional electrician for installation only
- Switch off before installation
- Do not touch when in use
- Keep away from hot steam and corrosive gas

Application Areas

Suitable for commercial and residential applications like office, supermarket, shop, school, hotel, restaurant, workshop, warehouse, home etc.

Certificate



Product Information

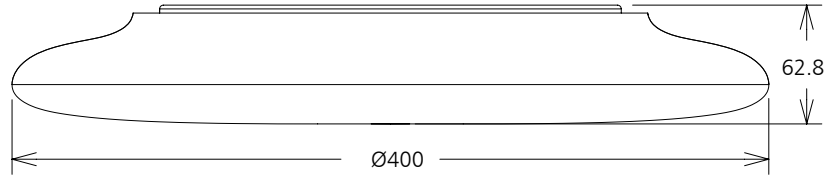

Technical Specifications

Model	Voltage	Power	Power Factor	Lumen (±5%)	Beam angle	CCT	Lifespan	CRI	Dimmable	Dimension
LT25-16-25W	AC100-240V	25W	≥0.9	2270	120°	3000K	50000h	≥80	No	Ø400*62.8mm
LT25-16-25W	AC100-240V	25W	≥0.9	2300	120°	4000K	50000h	≥80	No	Ø400*62.8mm
LT25-16-25W	AC100-240V	25W	≥0.9	2250	120°	5000K	50000h	≥80	No	Ø400*62.8mm
LT25-16-25W	AC100-240V	25W	≥0.9	2350	120°	5700K	50000h	≥80	No	Ø400*62.8mm
LT25-16-25W-D	AC230V	25W	≥0.9	2155	120°	3000K	50000h	≥80	Yes	Ø400*62.8mm
LT25-16-25W-D	AC230V	25W	≥0.9	2185	120°	4000K	50000h	≥80	Yes	Ø400*62.8mm
LT25-16-25W-D	AC230V	25W	≥0.9	2137	120°	5000K	50000h	≥80	Yes	Ø400*62.8mm
LT25-16-25W-D	AC230V	25W	≥0.9	2230	120°	5700K	50000h	≥80	Yes	Ø400*62.8mm

Driver data Sheet

Driver data	DIM	Non-dim
Input rated Voltage	AC230V	AC100-240V
Frequency	50Hz	50/60Hz
Input Voltage	AC200-240V	AC85-265V
Efficiency	≥88%	≥88%
Total load Wattage	25W±5%	25W±5%
Power Factor	≥0.9	≥0.9
Rated input current	≤0.14A	≤0.28A
Full load output Voltage	DC60-75V	DC60-75V
Rated output current	320mA	320mA
Output current range	320mA±5%	320mA±5%
Power tolerance	±5%	±5%
Current output tolerance	±5%	±5%
Dimming range	8%-100%	—
Dimmer	Triac dimmers	—
THD	≤20%	≤20%
Short circuit protection	PASS	PASS
Over voltage protection	PASS	PASS
Over temperature protection	PASS	PASS
Withstand voltage	AC3750V	AC3750V

Fixture Compatibility

Rated Wattage	Electrical Classification	Ingress Protection	Operating Temp	Operating Humidity	Storage Temp
25W	II	IP40	-20°C~45°C	0~90%	-20°C~65°C

Spectral Distribution

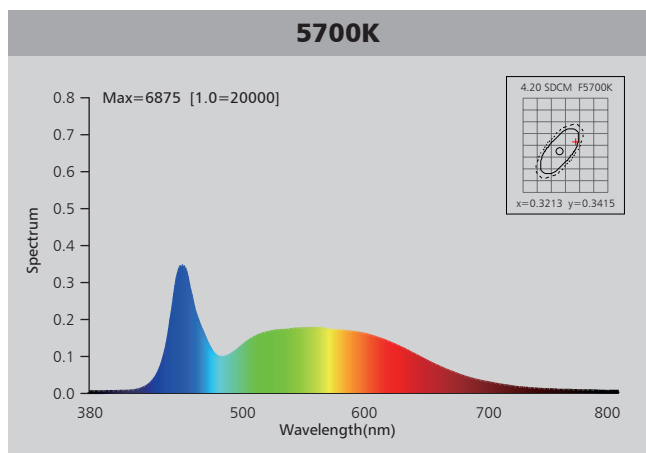
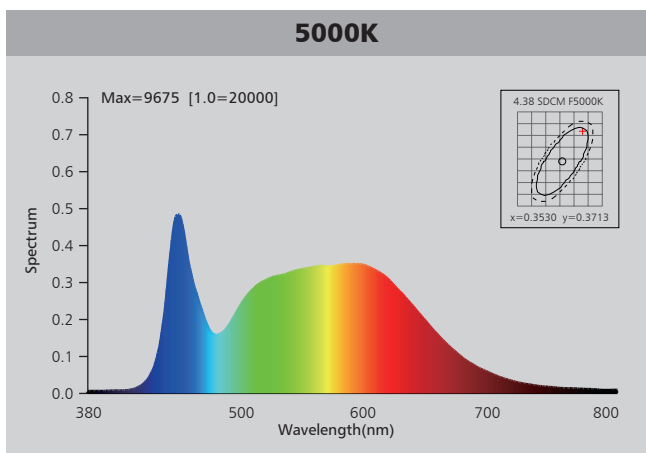
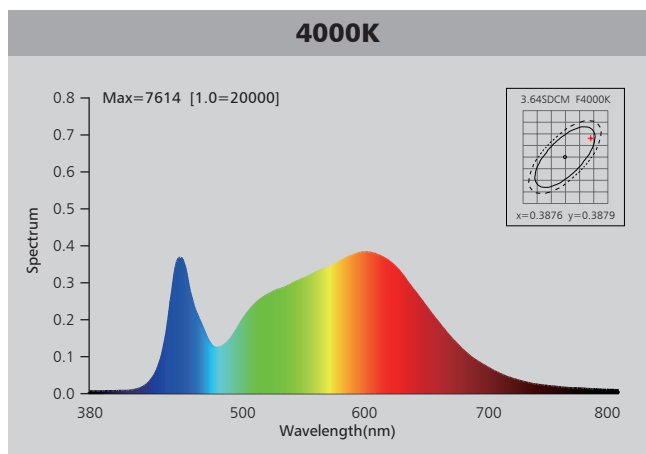
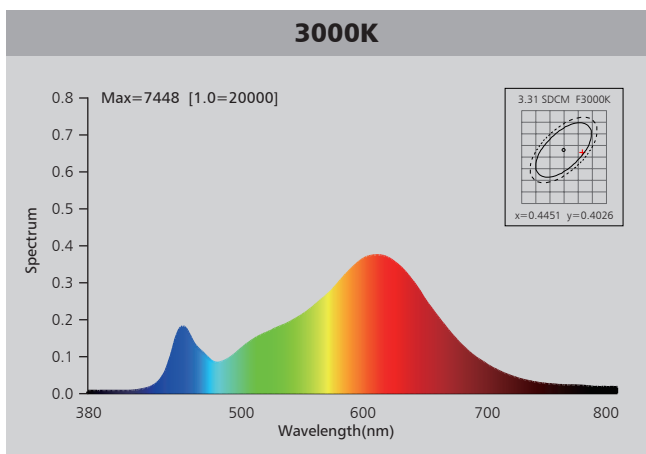

Photometric Diagram

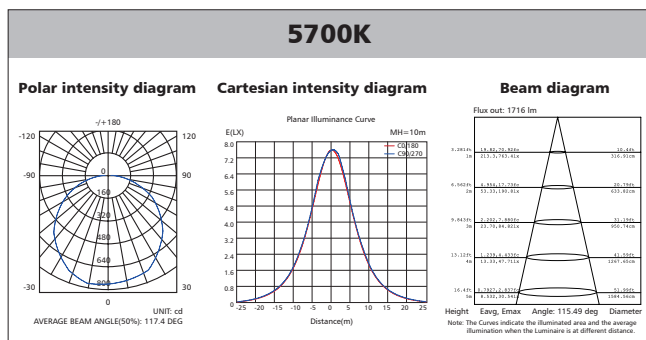
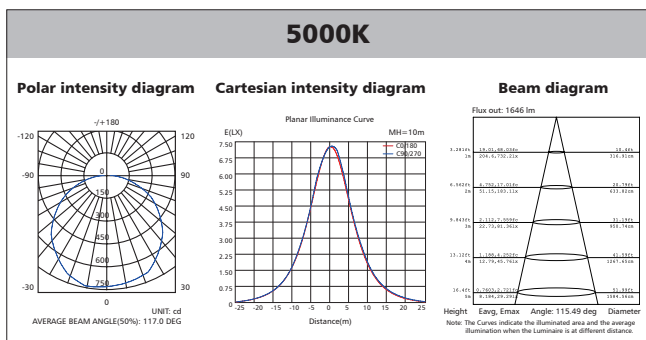
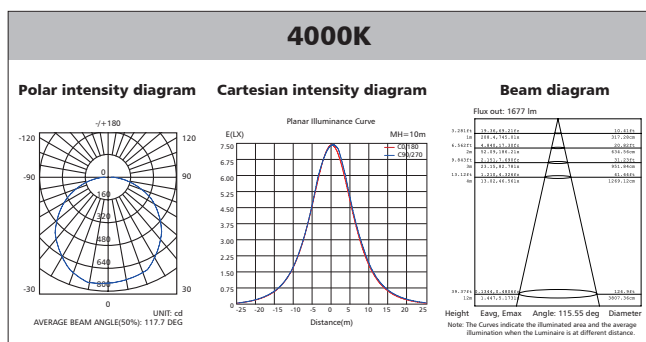
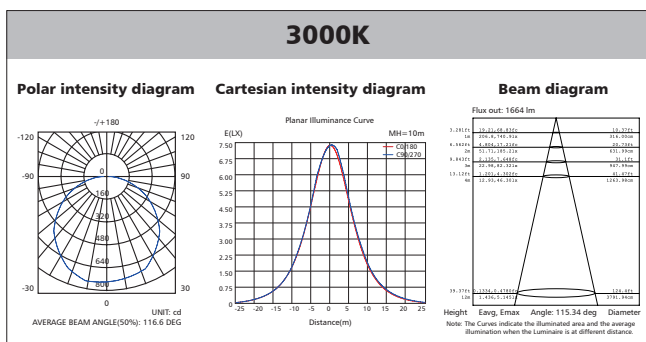

Polar Diagram Comparison

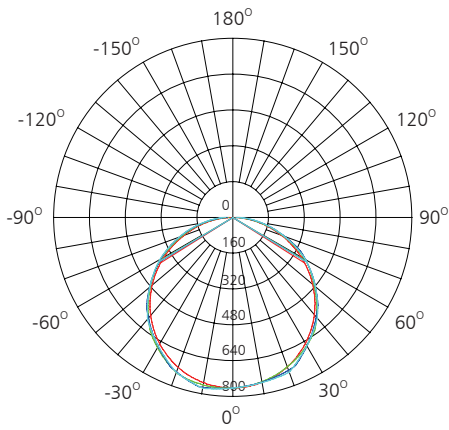

UNIT: cd

- C0/180, 115.5 deg
- C30/210, 118.4 deg
- C60/240, 117.9 deg
- C90/270, 117.9 deg



AVERAGE BEAM ANGLE (50%): 117.4 DEG

Driver lifetime & LED light decay rate

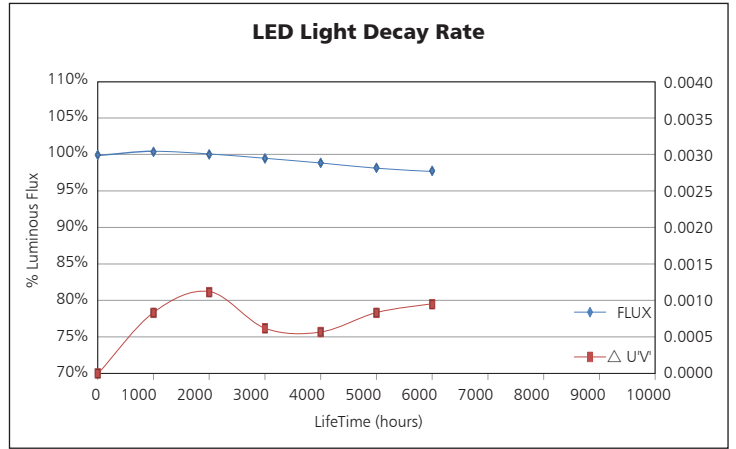
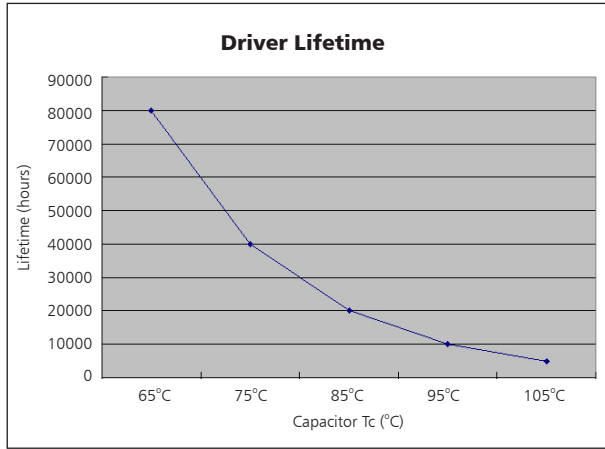

Temperature

- The testing is operated at 25°C
- The lifetime of capacitor, minimum of 5,000 hours if operated at 105°C, will be doubled whenever the temperature drops 10°C
- The highest withstand temperature of IC, MOS could be 120°C
- The highest withstand temperature of LED junction temperature is 150°C

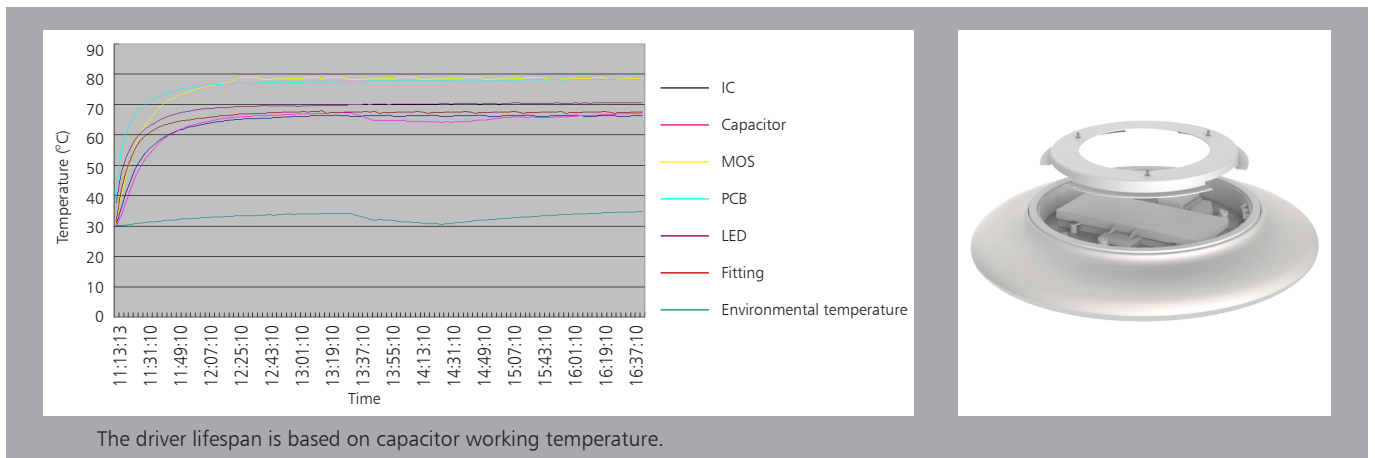

The driver lifespan is based on capacitor working temperature.

Installation

1. Take out ceiling light and accessory pack from box.

2. Using screwdriver turns the bracket in anti-clockwise direction and taking it out.

3. Determine mounting location and knock-in the plastic anchor into ceiling, fix bracket with screw into the ceiling.

4. Switch off, wiring "live", "Neutral" to terminal block respectively.

5. Aim the buckle at the the gap of installation bracket and push it upward, adjust the lamp's position clockwise and counter-clockwise to fit the lamp into the bracket, then rotate the lamp clockwise until it is fixed well.

6. Connect the lamp to the mains supply after finish the installation.

L = BROWN
N = BLUE

Packaging Information

	SIZE(CM)	N.W/pc (KGS)	G.W.(KGS)	Q'TY(PCs)
Carton	70*43*43	1.75	21.4	10

	CTNS	Q'TY(PCs)	VOLUME(CBM)
20" standard container	214	2140	28
40" standard container	428	4280	56

